



# Info Sheet DesignStand S2

The combination of the elegant design stand with reliable event technology enables sophisticated and first-class solutions. The equipment fully performs within the public's line of vision yet is discretely integrated in the space.



### Applications

This indoor stand for flatscreens can be used for trade show displays, as a preview monitor, or as a touch-screen table. The display holder can accommodate slanted projectors.



### Image Center

min. 42 cm  
max. 200 cm



### Mountings

Display holder  
120° rotatable



### Capacity

recommended  
diagonal display  
max. 60 inches  
max. 125 kg



### Baseplate

with decentralized  
mount

## S2 Set Components



### Mountings

1 x Display holder for VESA mount up to 30 x 30 cm, Audipack L&S5, or mounting on M10 screwthreads | 2,6kg



### Head

1 x 56 cm | 2,8kg



### Extensions

1 x 80 cm | 5,2 kg  
1 x 60 cm | 4,1 kg  
1 x 40 cm | 3,4 kg



### Baseplate with decentralized mount (-15 cm from the center)

1 x 4 cm | 20 kg



## Baseplate

Color: RAL 9005



## Head

Color: RAL 7035

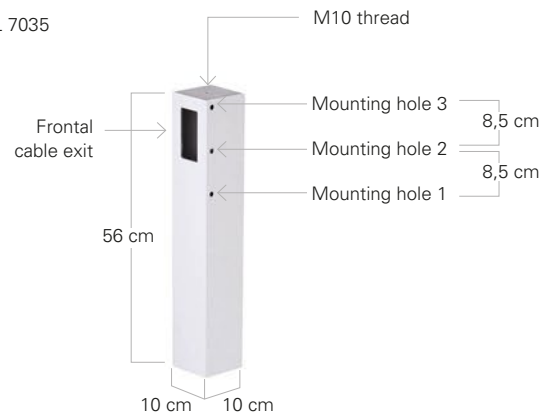

## Display Holder

Color: RAL 7035

### Display holder

The display holder can accommodate the following VESA measurements:

- 7,5 cm x 7,5 cm
- 10 cm x 10 cm
- 10 cm x 20 cm
- 20 cm x 30 cm
- 30 cm x 30 cm

The M10 screw thread is located directly over the universal head when the display is in the 180° position.

The Audipack bracket L&S5 (Ref 390967) can also be mounted.

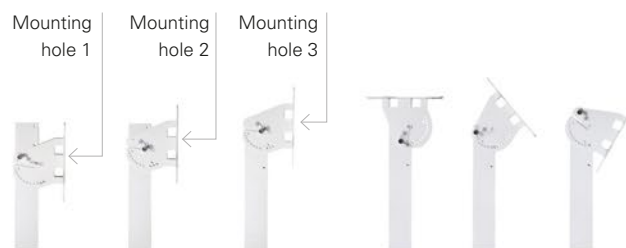
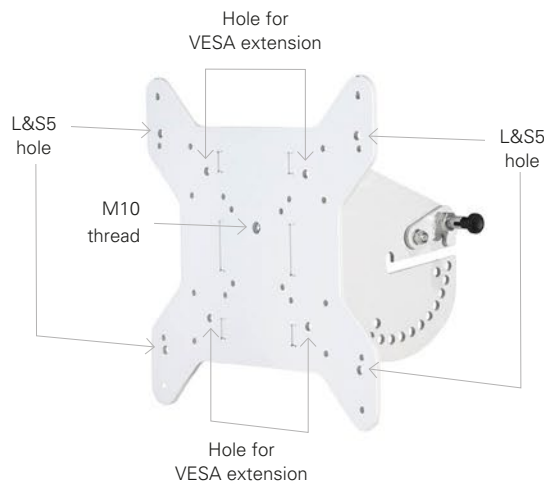

### Mounting hole

The display holder can be mounted on the universal head at three different heights. The three mounting holes are spaced at 8,5 cm intervals.

### Rotation

When mounting the display holder in mounting hole two and three, the display holder can rotate in 10° increments.



## Height Options

Color (Extensions): RAL 7035

Mounting 1: 90° / Hole 1

Mounting 2: 90° / Hole 2

Mounting 3: 90° / Hole 3

Mounting 4: 180° / Hole 2

Mounting 5: 180° / Hole 3

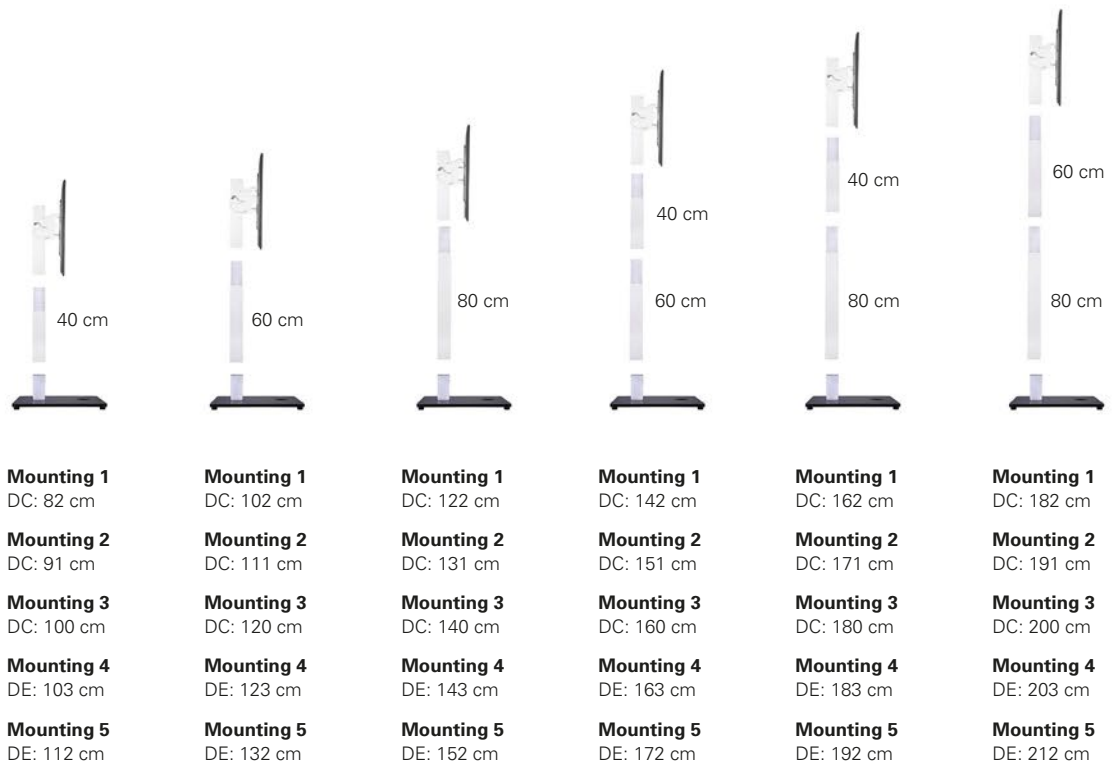

## Possible Angles

Color: RAL 7035

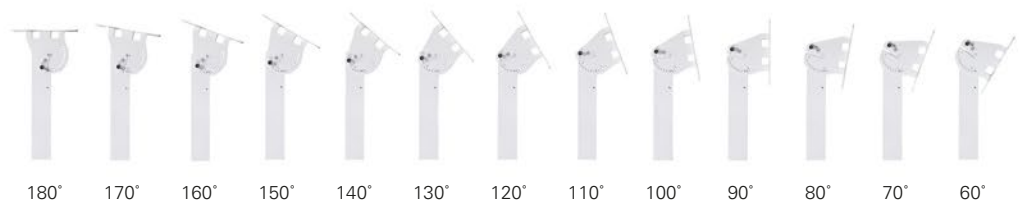



## Options and Attachments



### Wheel options

The baseplates S2 and S3 can be delivered with 32 M6 steel screw threads. Each corner contains four steel screw threads at a distance of 6 cm x 8 cm for Bluewheels (ex/Guitel 37024) and four steel screw threads at a distance of 3,5 cm x 3,5 cm for small wheels (ex/ Guitel 3703).

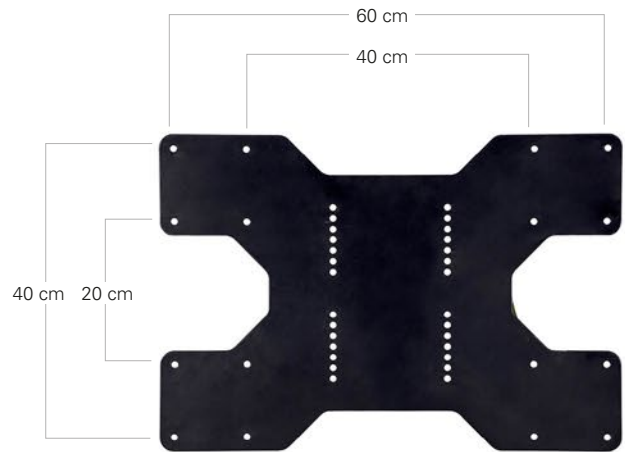

### VESA extension

A VESA extension can be screwed directly into the display bracket for displays with a VESA dimension larger than 30 cm x 30 cm. The VESA extension can also be mounted at a 90° angle on the display bracket.



### Stacking table

A stacking table can be mounted at each joint and on all of the models of the Design Pedestals to support laptops or keyboards. The table has a surface of 35 cm x 45 cm. The table and all Excellent extension components have an opening of 2 cm x 3 cm. This port is suitable for USB or power supply connections with most laptop and cable manufacturers.



## Impressions

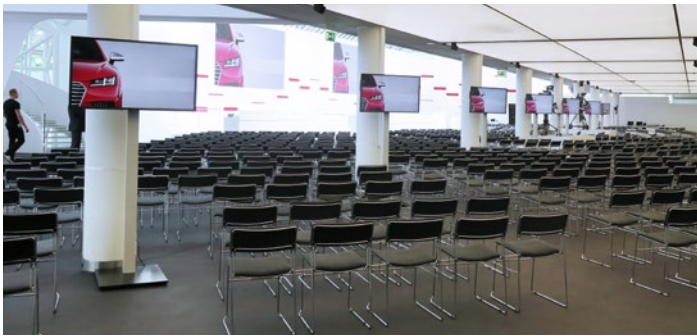

⌋ S2    ⏏ 1,8m    ⌋ Display holder, Landscape

⌋ S2    ⏏ 1,6m    ⌋ Display holder, Portrait

## Excellent Line DesignStand S2

### High-quality, quadratic column stand with rectangular baseplate for mounting displays.

The high-quality aluminum stand is composed of several 10 cm quadratic pipes in lengths of 40, 60 and 80 centimeters. The baseplate is made from solid aluminum, 65 cm x 55 cm x 2 cm (plus 2 cm rubber foot), **with decentralized mounting** for the square column. The square pipes are hollow and can be used to run cables. One can obtain varying heights through different combinations of the square pipes. The top of the stand forms a closed head unit with a frontal cable outlet and three mounting holes.

A mounting bolt can be inserted through one of the three mounting holes. The mounting bolt supports the display stand, which can rotate 120 degrees in 10-degree increments. Displays with VESA dimensions up to 30 cm x 30 cm can be directly attached to the display bracket. Larger displays are attached with the optional VESA extension plate. The display bracket has an M10 screw thread, which is centrally located above the universal head when the display bracket is in a horizontal position.

The square tubes, display bracket and head unit are RAL color 7035. The baseplate is powder-coated in RAL color 9005.

### The stand set contains the following components:

- 1 x Baseplate 55 cm x 65 cm x 2 cm, RAL 9005
- 1 x Quadratic pipe 40 cm, RAL 7035
- 1 x Quadratic pipe 60 cm, RAL 7035
- 1 x Quadratic pipe 80 cm, RAL 7035
- 1 x Head 56 cm, RAL 7035
- 1 x Display holder RAL 7035
- (VESA hole: 7,5 cm x 7,5 cm – 10 cm x 10 cm – 10 cm x 20 cm – 20 cm x 30 cm – 30 cm x 30 cm, hole for Audipack L&S5 Ref. 390967, hole for VESA extension M10 screwthreads)
- 1 x Mounting bolts 13 cm with four spring washers

One also has the **option** of ordering the baseplate with 32 M6 steel screw threads on the bottom. Eight screw threads are located in each corner of the baseplate. The distance between each screw thread is 60mm x 80mm for 100 mm swivel castors (ex/ Guitel 37024) and 35 mm x 35 mm for 50 mm swivel castors (ex/ Guitel 3703).

An **optional** stacking table can be ordered for each Excellent Line stand. The table can be inserted between two extensions.

A VESA extension for displays larger than 30 cm x 30 cm can **optionally** be directly fastened onto the display bracket. The VESA extension can also be mounted at a 90-degree angle on the display bracket.

### Manufacturer

H.O.F. ALUTEC

### Article

Excellent Line  
DesignStand S2

## Manufacturer

### H.O.F. ALUTEC GmbH & Co. KG

Brookstrasse 8 | D-49497 Mettingen | Telefon +49 (0) 54 52 – 97 33 10 | Fax +49 (0) 54 52 – 97 33 19 | sales@h-of.de

